

THE ULTIMATE  
**TIMBER**  
**ROOF SYSTEM**  
FOR CONSERVATORIES  
AND EXTENSIONS



*A warm and beautiful way of living*



# A **WARM** WELCOME

Join the rapidly growing number of homeowners across the UK enjoying the beauty, elegance and performance of Warmer Roof solutions. Designed to be used on new sun room extensions or as a replacement to your existing conservatory roof, featuring excellent thermal efficiency thanks to our premium honeycomb insulation. The highly insulated Warmer Roof will transform your home, adding value to your property and provide usable living space all year round.

The 'Warm Roof' design was conceived through the use of a unique modular pod system, pre-fabricated to speed up installation time and minimise disruption on site. The robust timber framework combats the risk of condensation in a way that similar aluminium structures can not, preventing issues in years to come giving total piece of mind.

All structural and building regulations are met thanks to careful design and engineering. The roof has been extensively tested and certified to ensure it not only complies but exceeds the current building regulation requirements for both structural and thermal performance.

Finished off externally with lightweight tiles, available in a wide range of colours to match your existing home. A clean internal plastered finish with optional spot lights and opening vents will make your new room no longer feel like a conservatory but a part of your home.



# REDEFINING THE WAY **YOU LIVE**

Is your conservatory too hot in the summer months but freezing cold in the winter? This is the problem many homes are faced with, meaning they can only use their conservatory through certain months of the year or are faced with extortionate heating bills trying to keep their conservatory at a comfortable temperature.

The Warmer Roof solves this problem through the excellent thermal performance making it the warmest roof on the market. The roof structure consists of 125mm multi-foil honeycomb insulation combined with an additional 53mm insulated plasterboard. The high performance insulation will help keep your conservatory cool during the summer and retain heat during the cold winter months providing you with a comfortable room all year round whilst saving you money on your heating bills.



**“Finally, a room we  
can use **all year round**”**



# WHY CHOOSE A **WARMER ROOF?**



## Thermal Performance

Exceptional thermal performance helps to keep your conservatory cool during the summer and retains heat during the winter.



## Building Control approved

The Warmer Roof has been tested and certified by Stroma Building Control, an accredited national building control approvals agency.



## Quick Installation

Our unique, pre-fabricated modular pod system ensures a speedy installation with minimal disruption to your home and garden.



## We are Eco-friendly

No construction material offers more environmental benefits than timber, and all of our timber is sourced from responsible companies with sustainable forest regeneration programmes.



## Customisable

Make it your own with a choice of external and internal finishes such as soffit and pelmet details, roof glazing and tile options.

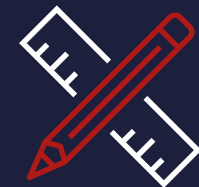

## Bespoke Service

Fancy a change? Our specialist in-house design team will re-design your conservatory roof from scratch.

# A HIGHLY INSULATED, **LIGHTWEIGHT, TIMBER SOLUTION**

Timber has been used as a construction material for thousands of years but its sustainability has seen its popularity grow, especially in the roofing industry. Timber is a far more effective insulator than aluminium due to tiny air pockets that minimise the heat conducting properties.

## KEY BENEFITS



### Premium materials

Our timber can grow for up to 120 years before harvesting. It's this slow growth that gives you distinctive durability and a premium finish.



### No risk of condensation

Timber is a far more natural insulator than aluminium as aluminium is one of the best conductors of heat and therefore prone to cold bridging.



### Versatile

Timber can be easily modified on site unlike aluminium. This can speed up the installation process should site conditions dictate changes in the installation



### Natural Insulator

Timber is a natural insulator. As a result, timber frame buildings are more thermally-efficient and require less energy, making them cheaper, easier (and greener) to heat.

“ Is **timber** really the answer?”

Just pop open your loft hatch and see for yourself the materials used for your house roof construction.





# Warmer Roof Performs Like No other

## TESTING & APPROVALS

### Rigorous Testing

The Warmer Roof has undergone extensive testing processes to ensure the system not only meets building regulation requirements but exceeds and outperforms like no other system, providing long lasting thermal efficiency. All results are submitted to Stroma Building Control for approval which forms part 1.4 of our System Approval Certification.

### Condensation Risk Analysis

A Condensation Risk Analysis evaluates the likelihood of interstitial condensation within the roof construction. These calculations are regularly required by building control to demonstrate compliance with building regulation requirements and are vitally important to ensuring you invest in a system that is high performing and hassle free.

### Think before you buy

Does the roof system you are investing in have all the relevant documentation to back up the Condensation Risk Analysis and U-Value Specification? Warmer Roofs timber construction coupled with the very best roofing insulation available means Warmer Roof passes with flying colours.

### Performance

The following calculations have been carried out by an independant Insulation Specification Specialist to achieve a 0.12 Wm<sup>2</sup>K U-Value in the roofs supplied as Warmer Roof Plus and a U-Value of 0.15 Wm<sup>2</sup>K for Warmer Roof Standard.

The calculations also undertook a Condensation Risk Analysis and further assessments that calculate the predicted dewpoint temperature. The results show there is no risk of condensation / moisture build up within the Warmer Roof. These results are paramount to ensuring no gradual degradation of the construction materials or chances of mould growth.

**Warmer Roof Ltd**  
Meets the technical requirements of the elements of the Building Regulations 2010 (as amended) specified in the attached schedule

**STROMA SYSTEM APPROVAL**

U-value: 0.12 W/m<sup>2</sup>K

Layer	Thickness (mm)	U-value	ΣU
External surface	5.0	0.0000	0.0000
1.Metrotile	15.0	0.0330	0.0330
2.Tile Mesh	12.5	0.0000	0.0330
3.Breather membrane	12.5	0.0180	0.0510
4.Orientated Strand Board	125.0	0.1900	0.2410
5.Low e cavity /150mm Rafter	12.5	0.0000	0.2410
6.Hybris /150mm Rafter	12.5	0.1000	0.3410
7.Low e cavity /150mm Rafter	12.5	0.0000	0.3410
8.Phenolic PIR/Taped & Sealed	12.5	0.0658	0.4068
9.Plasterboard	12.5	0.1000	0.5068
Internal surface	5.0	0.0330	0.5400

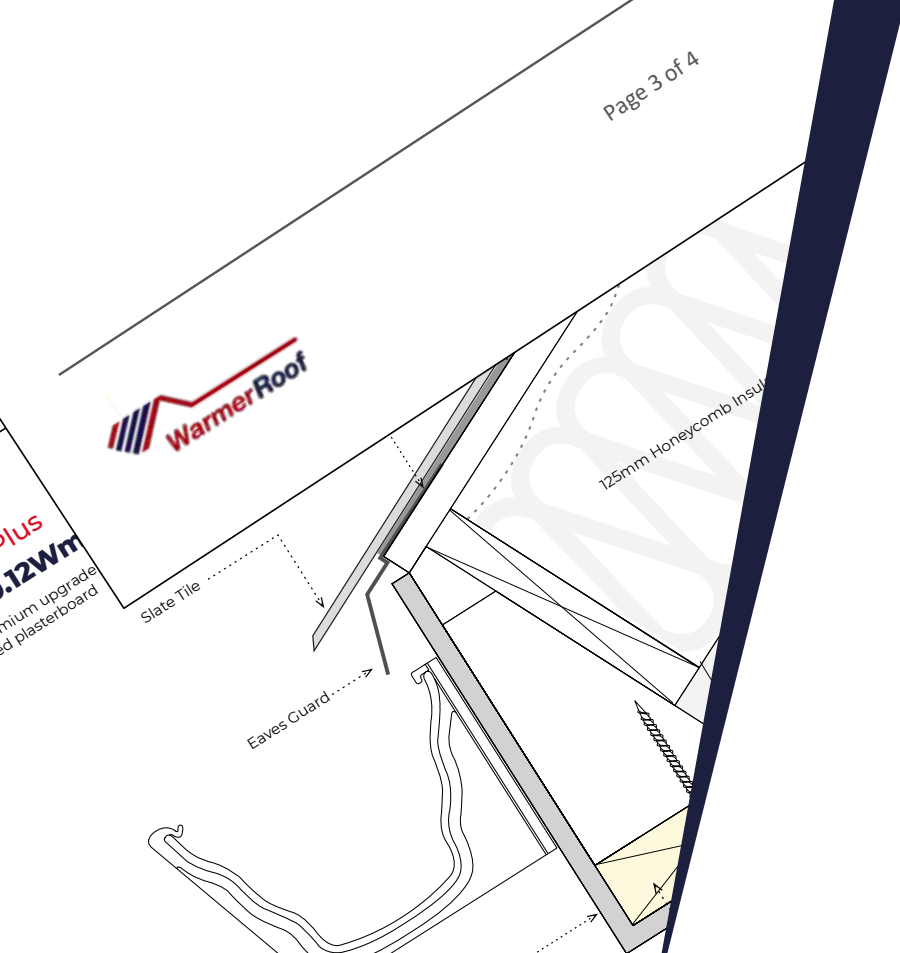
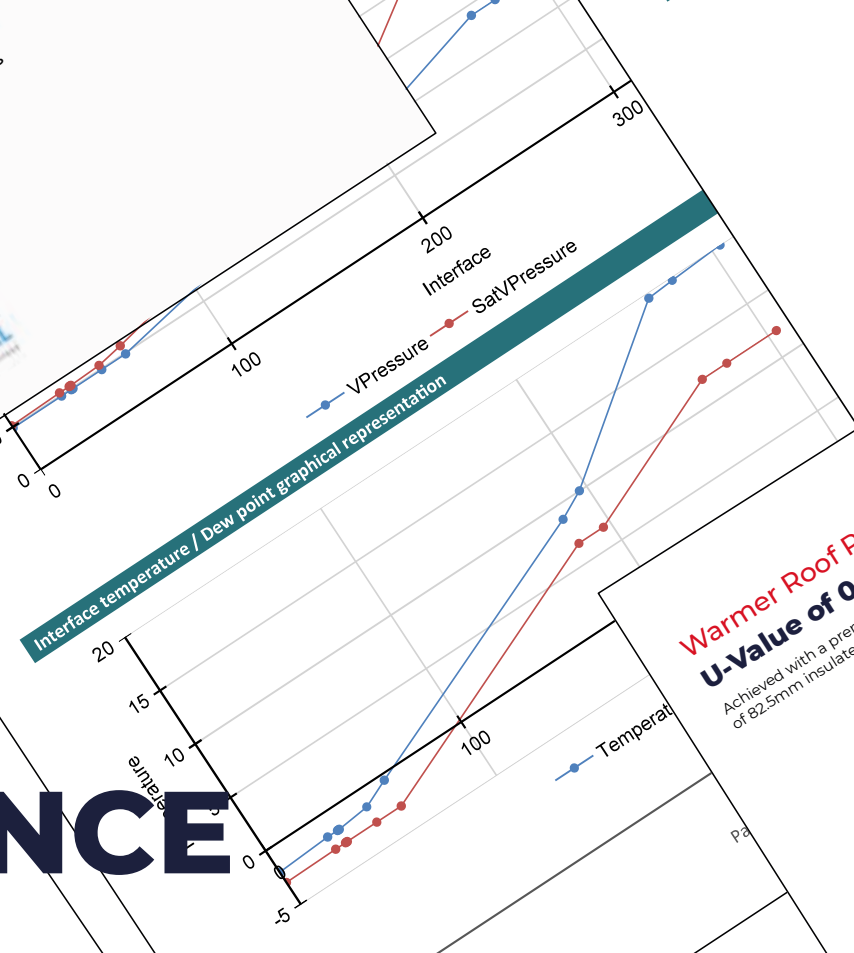

**U-VALUE CALCULATOR REPORT**

**Warmer Roof Standard**  
Total thickness: 224mm **U-value: 0.15 Wm<sup>2</sup>K**

**Warmer Roof Plus**  
Total thickness: 254mm **U-value: 0.12 Wm<sup>2</sup>K**

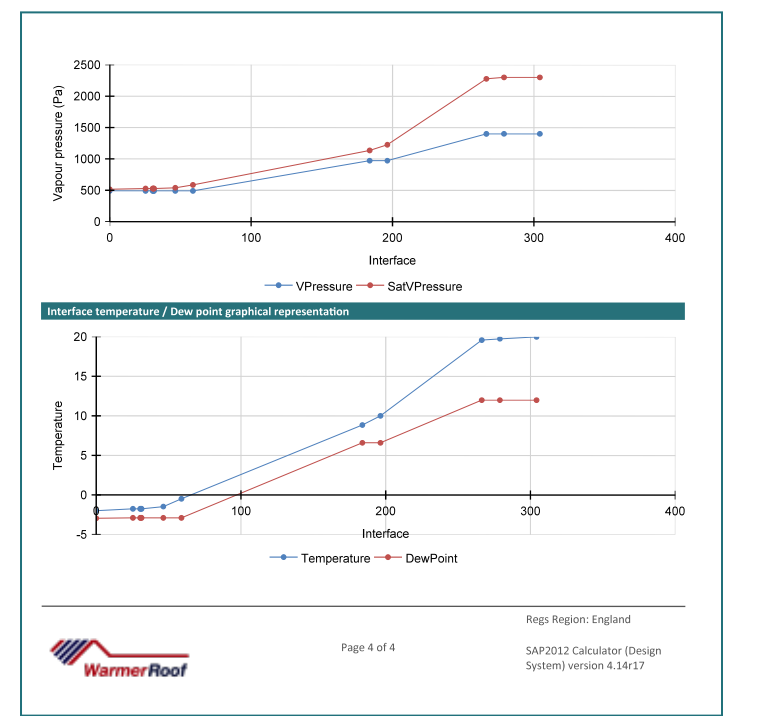

# UNRIVALLED PERFORMANCE



# Structural Calculations

For  
**Warmer Roof Ltd**  
Conservatory Replacement Roof System

## Pitched Roofs

Job ref: 18186  
Revision Date: June 2018

Project: Conservatory Roofs	Job Ref: 18186
Checked: SA	Sheet No.
Checked:	Date: June 2018

# UNRIVALLED STRENGTH & RIGIDITY

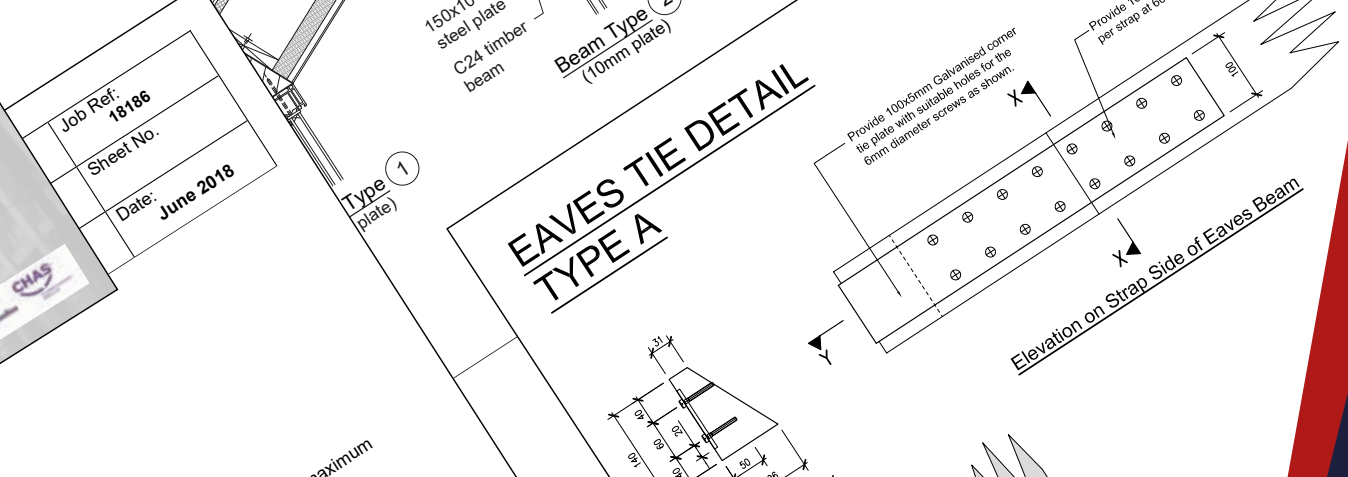
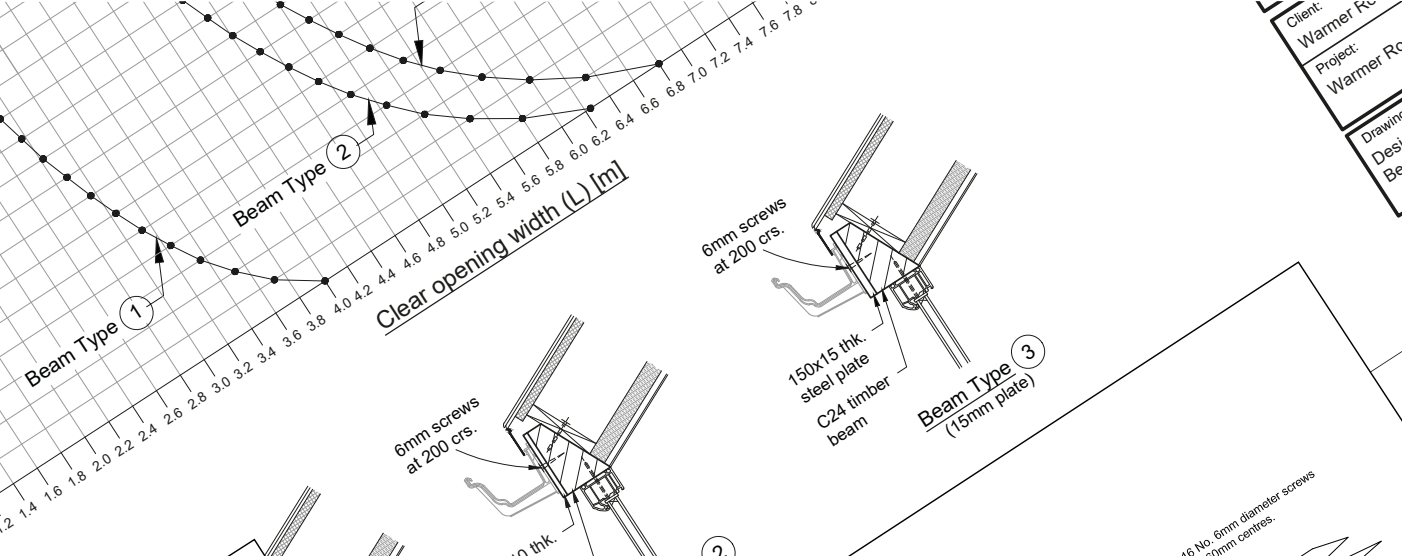

**4.0 SNOW LOADING**  
Refer to BS 6399-3:1988  
Clause 4.3.1  
Snow loading to be taken as the worst between:  
a) The uniformly distributed snow load; or  
b) The redistributed snow load (drift)

Roofs will be designed for two snow load areas (see snow map) to a maximum height above sea level of 200m.

See following table for snow and snow drift loadings calculations.

Basic Snow Load	Roofs up to 30 Degree Pitch	Drift Snow Load (max)
< 0.5 kN/m <sup>2</sup>	Uniform Snow Load	2.05 kN/m <sup>2</sup>
> 0.5 kN/m <sup>2</sup> < 0.8 kN/m <sup>2</sup>	Uniform Snow Load	3.10 kN/m <sup>2</sup>

shape coefficient for the 45 degree roof is 0.8 [(80-45) / 30] = 0.4  
and therefore the snow loading will be halved.

Snow Loadings for 45 Degree Roof Pitch	Drift Snow Load (max)
Uniform Snow Load	1.02 kN/m <sup>2</sup>
0.26 kN/m <sup>2</sup>	1.55 kN/m <sup>2</sup>
0.39 kN/m <sup>2</sup>	

each case (based on a 8m x 8m roof)

= 24.96 kN  
= 24.80 kN  
= 48 kN



## STRUCTURALLY APPROVED BY SPECIALIST ENGINEERS

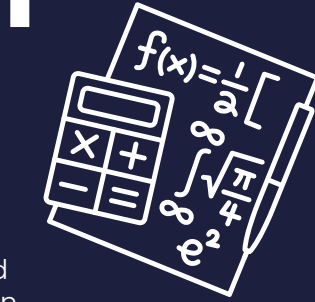

**Rigorous Testing**  
The Warmer Roof is tested and approved by qualified independent structural engineers to ensure all design elements comply and exceed the requirements for Building Regulations as well as ensuring the system is safe and fit for purpose. Every aspect of the Warmer Roof is rigorously tested using specialist software to ensure any structural issues are highlighted. These results are then compiled into a structural report which consist of formulas, span tables and design drawings all of which are submitted to Stroma Building Control for approval. These calculations form a vital part of the System Approval Certification.

Structural Calculations hold highly confidential information relating to the Warmer Roof System. Full structural calculations will not be provided to 3<sup>rd</sup> parties due to the confidential nature of material contained within the calculations which relate directly to the make-up of the Warmer Roof. These calculations have been provided to Stroma Building Control with suitable Non-Disclosure Agreements (NDA) having been entered into, and will not need to be provided again for all Stroma Building Control applications.







**JOIN THE THOUSANDS  
OF HAPPY CUSTOMERS**



“  
I am so glad we took the advice from family to use Warmer Roof. I feel like I have finally got the conservatory I have always wished for. I can even read my books in peace without hearing the rain hitting the roof! ”

**Mr & Mrs Lavelle**  
Warmer Roof customer



“  
I can't believe the difference its made! I can now make use of my conservatory throughout the year. It was always like an oven during the summer and freezing cold in the winter months

I have even recommended a Warmer Roof to all my family and friends. ”

**Mrs Armstrong**  
Warmer Roof customer







# PRECISION, **INNOVATION** AND CRAFTSMANSHIP ROLLED INTO ONE

All of our roofs are manufactured using state of the art CNC machinery. This provides a more precise timber cutting method allowing us to produce a high quality product whilst overseeing all quality control through ISO 9001 manufacturing systems. The roof is assembled by our highly experienced in house production team to ensure perfection is maintained

Warmer Roof prides itself in having some of the most highly skilled designers continuously producing innovative and exciting ideas to improve our product. If you want something completely different or would like to discuss the best option for you, speak to our friendly team for professional advice.

ISO 9001 (Quality Management Systems) and ISO 14001 Environmental Quality Management Compliant



Certificate No 328362020



Certificate No 328362020



Certificate No 328372020



## **VAULTED CEILINGS**

Thanks to our structurally engineered steel corner braces which are completely concealed, you are able to have a clean vaulted ceiling without the need of Trusses, Tie bars / Tie wires on any pitched roof up to 5 x 5m.





Whether you have a conservatory or modern new build extension, Tapco Slate adds elegance and tradition to your Warmer Roof. With a textured surface and riven edges these tiles mimic the appearance of genuine slate but are much lighter in weight and are manufactured from a recyclable blend of limestone and polypropylene.

- ✓ As low as 12kg per sq metre
- ✓ Building Control standard
- ✓ Pre marked nailing and exposure guides
- ✓ Fully tested - fire rating wind, driven rain & water absorption.
- ✓ Easy to cut
- ✓ 40-year warranty

CHOOSE A COLOUR TO **COMPLEMENT** YOUR HOUSE ROOF TILES...



Stone Black



Pewter Grey



Brick Red



Red Rock

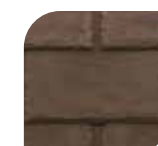

Chesnut Brown



Plum

## STYLISH, DURABLE & LIGHTWEIGHT



Metrotile Shingle is a simple but elegant tile solution for your Warmer Roof. Made from galvanised steel sheet with a stone-coated finish these tiles are practical, economical and sustainable. Metrotiles Shingle have been designed with a unique "hidden-fix" system leaving no nail exposed, preventing rainwater from corroding the nails.

- ✓ As low as 6.1kg per sq metre
- ✓ Building Control standard
- ✓ Hidden Fix System
- ✓ Rigorously tested to withstand harsh weather conditions and vandalism
- ✓ Highest possible external fire resistance rating
- ✓ 40-year warranty

CHOOSE A COLOUR TO **COMPLEMENT** YOUR HOUSE ROOF TILES...



Charcoal



Antique Red



Moss Green



Burnt Umber



Ebony

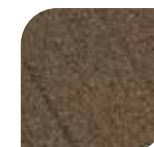

Iron bark



Scarlet



Bister Brown



Coal Black

## LIGHTWEIGHT & SUSTAINABLE



# STYLISH & DURABLE WITH A TRADITIONAL **SLATE** APPEARANCE

Britmet's Liteslate is our innovative synthetic slate roofing tile option made from 90% recycled polymers with all the characteristics you can expect from a traditional slate tile. Liteslate offers an authentic finish with riven edges, traditional colour choices and impeccable durability.



Lightweight - From 10kg per sq metre



Fire rating BS476-3



40-year warranty against weather penetration



Quick and easy installation

CHOOSE FROM THE **LARGEST** STANDARD SLATE **COLOUR RANGE IN THE UK**

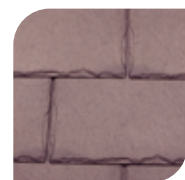

Amethyst



Ash



Charcoal



Sunset



Sunshine



Slate

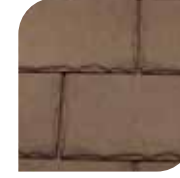

Oak

15

**BRITMET**  
LIGHTWEIGHT ROOFING

**LITESLATE**

**12°**  
MIN



Made In Britain

# STONE COATED GALVANISED STEEL WITH AUTHENTIC **SHINGLE** EFFECT

The Britmet Shingle tile is available in the largest standard colour range in the UK. With all the characteristics you could expect from traditional shingle, the Britmet Shingle is unique with a full dry-fix, interlocking hidden-fix design to keep your roof flush from fixings. Unlike traditional shingle, our lightweight design offers the perfect solution to any Warmer Roof project.



Lightweight- Under 7kg per sq metre



Fire rating AA classification



40-year warranty against weather penetration



Interlocking hidden-fix design for quick and easy installation

**UNRIVALLED** COLOUR RANGE TO **CHOOSE FROM...**



Bramble Brown



Raven



Titanium Grey



Rustic Brown



Rustic Red



Rustic Terracotta



Smoked Oak



Tartan Green

**BRITMET**  
LIGHTWEIGHT ROOFING

**SHINGLE**

**15°**  
MIN



Made In Britain

16



# DON'T ALLOW HEIGHT RESTRICTIONS TO SCUPPER YOUR DREAM CONSERVATORY



**BRITMET**  
LIGHTWEIGHT ROOFING

**PANTILE 2000**

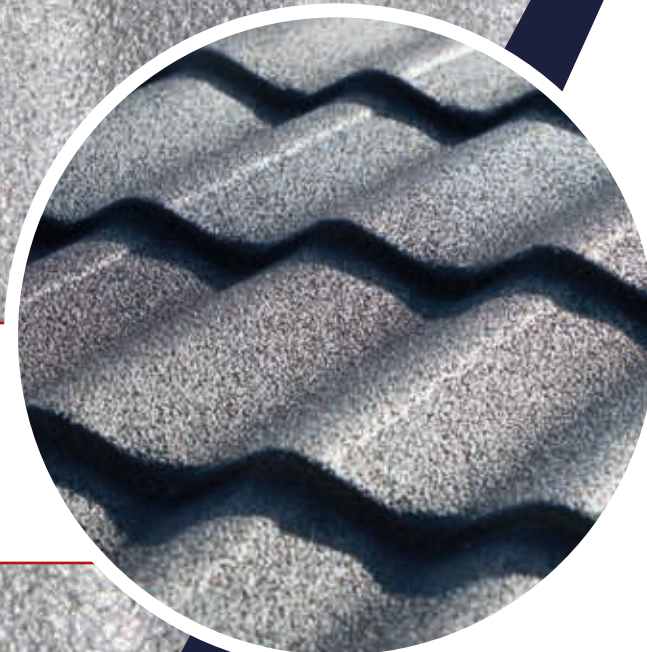

## DESIGNED TO GIVE A TRADITIONAL TILE APPEARANCE



Britmet's Pantile 2000 is the most innovative lightweight tile effect sheet in the construction industry. This market-leading product is the lowest BBA approved lightweight tile sheet in the world as it can be fixed to a roof pitch as low as 5°, backed with a weather penetration guarantee, making this the ideal solution for your 'low-pitched Lean-To' project. For peace of mind, the Pantile 2000 is manufactured as a made to measure tile effect sheet, custom made to your required rafter length, rapidly reducing installation time. At a 0.9mm thickness gauge Britmet's Pantile 2000 is renowned for offering an elegant, secure, anti-vandal roof solution.



Full length sheets for quick and easy installation



Custom made to suit any rafter length



Extremely low pitch- Min 5 degrees



40-year warranty against weather penetration



Fire rating AA classification



Lightweight- weight as laid per m2: 11kg



Antique Red



Charcoal

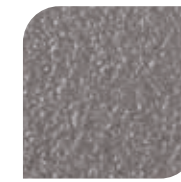

Mid Grey

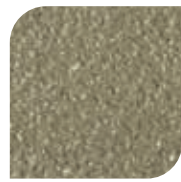

Sage Green



Terracotta



Tudor Brown

\* Cover width = 1040mm



# THE MOST THERMALLY EFFICIENT ROOF SYSTEM ON THE MARKET

U-Value of  $0.12\text{Wm}^2\text{K}$



## MAKE HUGE SAVINGS ON YOUR ENERGY BILLS



With energy bills constantly rising it is now even more important to invest in a roof system that is thermally efficient, preventing heat loss through your conservatory roof and providing a temperature-controlled room all year round.

Warmer Roof have launched the new and improved system, Warmer Roof Plus, now offered as a premium upgrade with a U-Value of  $0.12\text{Wm}^2\text{k}$  making this the most thermally efficient, high performing roof system on the market to date. A multi-layer honeycomb insulation and premium insulated plasterboard provide even more thermal and vapour protection and in short helps keep your conservatory cool during the summer and warm during the winter, keeping your energy bills to a minimum.

**125mm Honeycomb Insulation**  
**82.5mm Insulated Plasterboard**

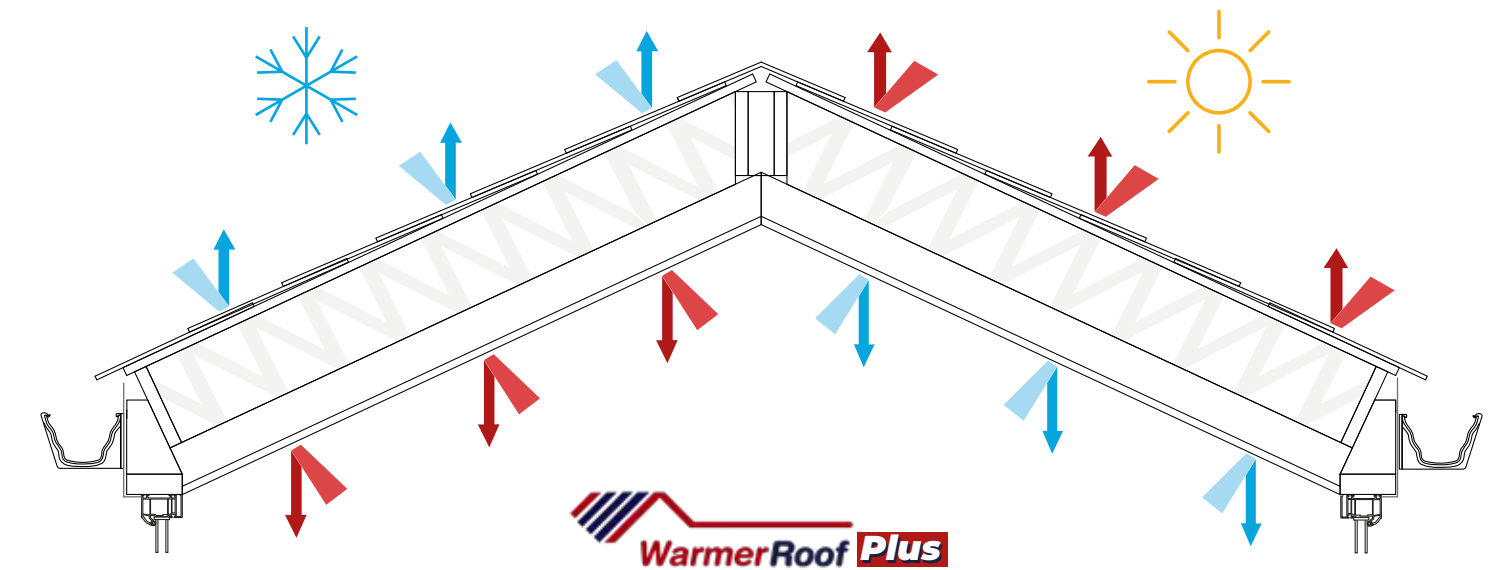



# LONG LASTING AIRTIGHTNESS, THERMAL AND ACOUSTIC INSULATION

HYBRIS is a reflective insulation product based on a honeycomb structure made of shaped polyethylene foams glued to aluminium coated polyethylene foils. Its high thermal performance is provided by a special structure composed of a large number of low emissivity cavities, protected from dust and excessive air movement. Moreover, the low emissivity external films provide additional thermal resistance, when associated with air cavities. HYBRIS significantly reduces building energy consumption while providing maximum comfort. With a core declared thermal conductivity ( $\lambda_D$ ) as low as  $0.033 \text{ Wm}^2\text{K}$ , HYBRIS provides a thermal resistance as high as  $6.20 \text{ m}^2\text{K/W}$



# HYBRIS

## 3-in-1 honeycomb insulation



Acoustic Performance



125mm Thickness



Vapour Barrier

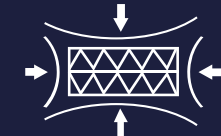

Flexible & Durable



Eco-friendly Conception



Light



Dual Performance



Airtight



High Thermal Performance



No Fibres or Dust

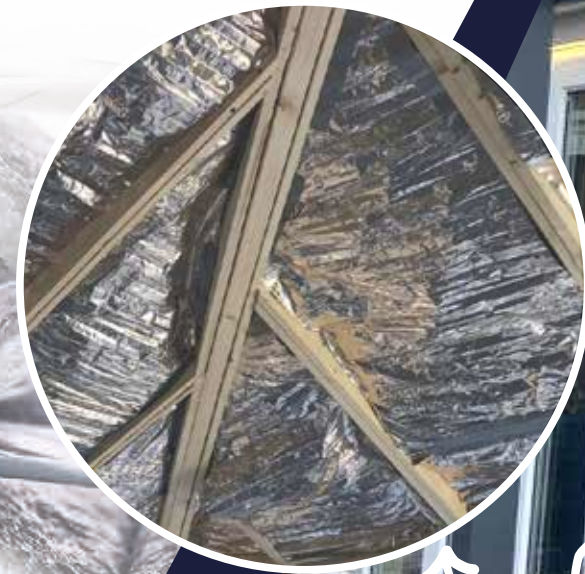

pre installed  
within roof  
structure

**Performance**  
Warmer Roof prides itself on using the most high performing, premium roof insulation available to maintain its reputation for exceptional thermal efficiency.



# CREATE THE LOOK



STYLISH GUTTERING AND FASCIA OPTIONS THAT **BLEND IN WITH YOUR HOME**



Double Ogee uPVC Gutter Systems

### Gutter colour options

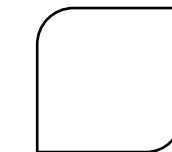

White



Brown



Anthracite Grey



Black



10mm Square Leg Fascia

### Fascia colour options

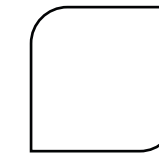

White



Woodgrain Black Ash



Woodgrain Light Oak



Woodgrain Irish Oak



Woodgrain Rosewood



Woodgrain Anthracite



Woodgrain Cream



Woodgrain Chartwell Green



# DESIGNED TO FIT ALL SHAPES AND SIZES

The ultimate conservatory roof replacement system also perfect for new build extensions.

Thanks to our unique pod system and innovative design, the Warmer Roof can be adapted to all roof styles. Our timber frame allows us to create completely bespoke designs suited to the space you have available.

## STANDARD ROOF OPTIONS



### Edwardian

A simple but effective shape made up of three sides sloping towards ridge.

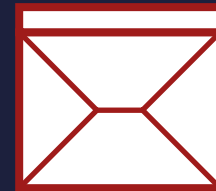

### Double Edwardian with box gutter

Double sided Edwardian with aluminium box gutter fixed directly to house wall.



### Victorian

One of the most popular shapes. Made up of three angled facets to front of conservatory.



### Victorian 5 Bay

Same shape as a standard Victorian with the addition of two extra hips giving you five angled facets to front of conservatory.

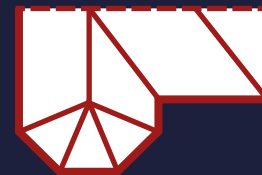

### P-Shape

A bespoke roof, combining any two styles.



### Lean-to

A simple, mono pitched roof offers clean lines. Perfect for adding large opening vents.

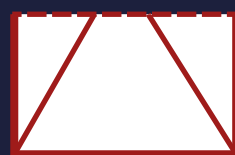

### Hipped lean-to

Same shape as a Lean-To with the addition of either one or two hips to create sloping side(s).

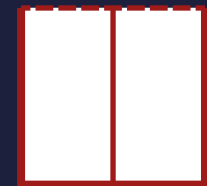

### Gable

A contemporary look with the option of a glass gable frame to front to maximise natural light.

## BEAUTIFUL INSIDE AND OUT







# PEACE OF MIND



### Warranty

25 Year manufacturing warranty.  
40 year tile manufacturers warranty .



### Building control compliant

Be assured your roof is approved by Stroma Building Control. Certification granted after application from installer and inspections made.



### Tested and approved

Structurally approved by our own specialist engineers.



### Genuine product

All our roofs are delivered in sign written vehicles so you know a genuine Warmer Roof product is at your door step.

## WE OFFER OUR CUSTOMERS A 25 YEAR MANUFACTURING GUARANTEE

When making an investment to your home, it is vitally important you can trust the product you are purchasing. With a Warmer Roof you will receive a tried and tested roof system that is fully approved.

Warmer Roof exclusively designs and manufactures a range of products, this helps us to centrally control the process right through to delivery. Every detail has been scrutinised and all components have been tested rigorously to ensure ultimate perfection throughout. You can be sure to receive a quality product, specifically designed for purpose with long lasting performance.

The Warmer Roof warranty is with the purchaser of the product, therefore in the majority of cases, this will be the installer of the product. In the first instance the end user should contact their original installer.



★
25
YEARS
★

MANUFACTURING WARRANTY





# THE HASSLE-FREE SOLUTION TO OBTAINING BUILDING CONTROL APPROVAL ON YOUR WARMER ROOF PROJECT

Building Control is often perceived as a burden within the industry that puts off perspective trade customers from venturing into the solid roof market. When dealing with the local authority or any other third-party building control that do not fully understand the system being installed, it can cause huge delays on the project, countless queries being raised and endless amounts of documentation to be provided. Warmer Roof have created a process which eradicates all the above, meaning a smooth process from start to finish.

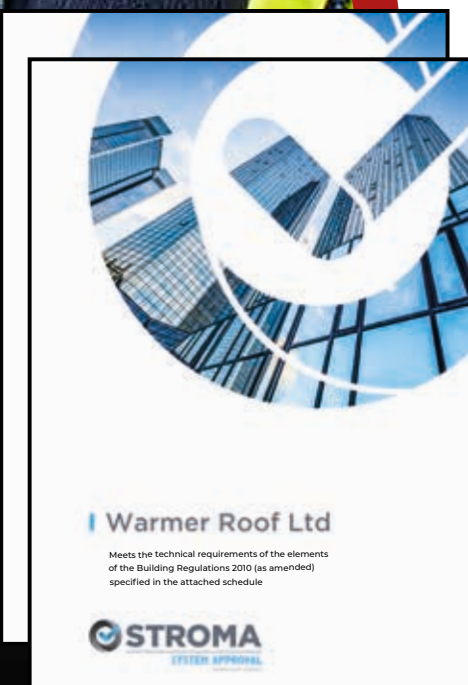

## System Approval

Your Warmer Roof has been independently tested and certified by Stroma, an accredited national building control approvals agency. These tests involved detailed analysis and verification of the roof system from independently sourced structural calculations, along with further assessment checks on thermal performance and condensation risk analysis and as a result granted with a System Approval. All Warmer Roofs should go through the Stroma System Approval process when obtaining Building Control certification. Alternatively failure to use Stroma Building Control could result in your project being delayed and if the Warmer Roof System is not understood by Local Authority or Private Building Control, additional costs and the possibility that a Certificate not being issued, as Building Control is subjective to interpretation.



All applications to be submitted by the relevant Warmer Roof installer prior to installation. Applications cannot be made after the works have started and Stroma will need at least 5 days' notice to register the application. If work has already started Stroma will not accept the building control application.

## STROMA NOW HAVE A DEDICATED IN-HOUSE TEAM SPECIALISING IN WARMER ROOF BUILDS

We understand the process can seem daunting for any first-time Building Control users. For this reason, Stroma have created a dedicated team specialising in Warmer Roof applications. This personal touch is designed to further enhance your building control process providing expert advice from start to finish.

To assist in this process and to save unnecessary heartache and delay in obtaining Building Control, Warmer Roof have partnered with Stroma Building Control in order that your project becomes an effortless and streamlined procedure.

“ We are here to guide you every step of the way ”







**FALL IN LOVE WITH YOUR**

**CONSERVATORY AGAIN**



# ROOFING EXCELLENCE



Other Timber  
Roof Systems

Aluminium  
Roof Systems

Clad  
Overs

	WarmerRoof	Other Timber Roof Systems	Aluminium Roof Systems	Clad Overs
<b>Building Control Approved (system approvals)</b>	✓	Some	Some	✗
<b>U-Value of 0.12Wm<sup>2</sup>K</b>	✓	✗	✗	✗
<b>'Shaped' Glass Panels</b>	✓	✗	✗	✗
<b>No chance of condensation</b>	✓	Some	✗	✗
<b>Premium Multi Foil Insulation</b>	✓	✗	✗	✗
<b>Pre assembled modular system</b>	✓	Some	✗	✗
<b>Marketing Support</b>	✓	Some	Some	✗
<b>Soffit &amp; Pelmet Features</b>	✓	Some	Some	✗
<b>Insulated Plasterboard included with kit</b>	✓	✗	✗	✗





# A WARM ROOF WITH GREEN CREDENTIALS

## WE TREAT THE ENVIRONMENT LIKE OUR BEST FRIEND...



### Clean air

Think of trees as the world's air filtration system. Every day, through photosynthesis, forests all over the globe ingest CO<sup>2</sup>, locking in the carbon, and generating fresh oxygen. Over a year, just one acre of forest will absorb twice the CO<sup>2</sup> produced by an average car.



### Energy efficiency

The energy used to harvest, process and deliver the timber for our roofs is extremely low. This reduces the typical embodied carbon footprint of a timber structure. We use a state of the art wood burner, with an emissions regulator to produce energy for factory (hot water and heating)



### Wood shavings

All our wood shavings are collected and bagged up for distribution. We supply to small local businesses free of charge.

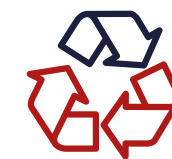

### Minimal waste

We use recycled materials during production to dramatically reduce waste to landfill. The timber mills only use timber harvested from replenishable sources. Approximately 50% of log volume becomes sawn timber. The rest is used by the pulp industry and wood board industry.



### Planting

All timbers in our production process are sourced from companies involved in using timber from replenishable forest programmes and where three trees are re-planted for every one used. Harvesting and replanting forests sustainably, keeps the tree stock young and growing, which maximises the capture of carbon.



### CO<sup>2</sup> absorption

Trees absorb most CO<sup>2</sup> whilst they are growing, then as they age absorption declines. Each cubic metre of timber locks in about a tonne of carbon. Unless wood is either burnt or rots, the carbon remains safely stored.



### Wildlife

Before deciding which trees to fell, our timber supplier will fly drones to identify zones that should be left alone. By leaving certain areas of woodland undisturbed, we ensure that wildlife continues to flourish.



### Exceptional performance

There is no construction material available that offers more environmental benefits than timber does. Renewable, non-toxic, recyclable, bio-degradable and forests absorb CO<sup>2</sup>. Creating timber also uses far less energy than steel or aluminium.



NO LONGER A  
**SAUNA** IN THE  
SUMMER OR  
**FREEZER**  
IN THE  
WINTER

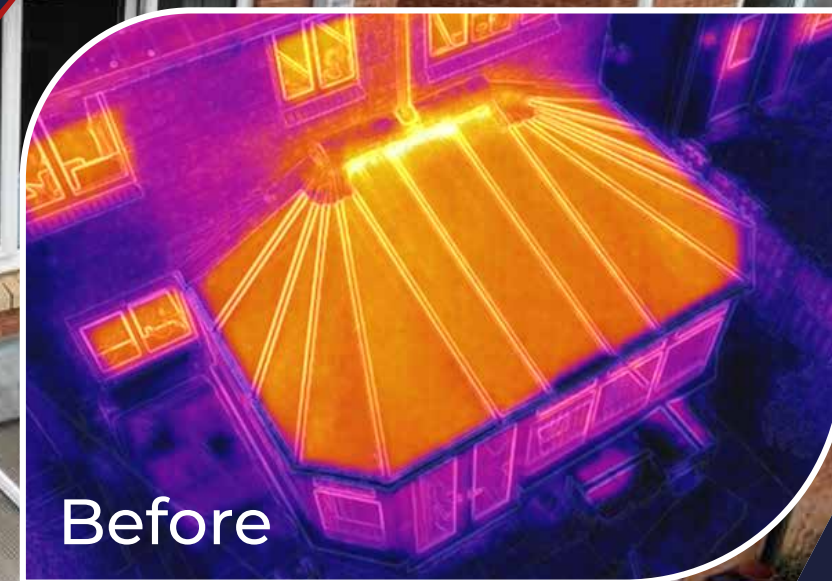

# CASE STUDY



## Overview

Thermal imaging is a process where a thermal camera made up from a lens, thermal sensor, processing electronics and a mechanical housing, captures and creates images by using infrared radiation and converts this information into a coloured visual image. The image results are displayed using colours which are usually, white, yellow, red, purple or blue where white is the hottest and blue is the coldest. Using this technology allowed us to quickly identify regions of excessive temperature or sources of wasted heat energy and compare the two results.

In these drone images you can see clearly where there is excessive heat loss through the original Polycarbonate roof system which is indicated as yellow and orange. In comparison the results produced from a new Warmer Roof are clear to see with far less wasted heat energy passing through the roof structure resulting in reduced energy bills and a conservatory that can be enjoyed all year round. This is achieved through the use of our premium multifoil honeycomb insulation coupled with an additional barrier of insulated plasterboard.





ALL WARMER ROOFS  
ARE MANUFACTURED  
**IN OUR UK FACTORY**  
FOR ULTIMATE PERFECTION  
AND QUALITY CONTROL

\* Call our team to arrange your  
factory visit. All trade customers  
welcome.



# THE WARMER ROOF BUILD UP



“ WE WILL TRANSFORM YOUR ROOM, PROVIDING YOU WITH **ALL YEAR ROUND LIVING SPACE** ”

..... 100% SUCCESS

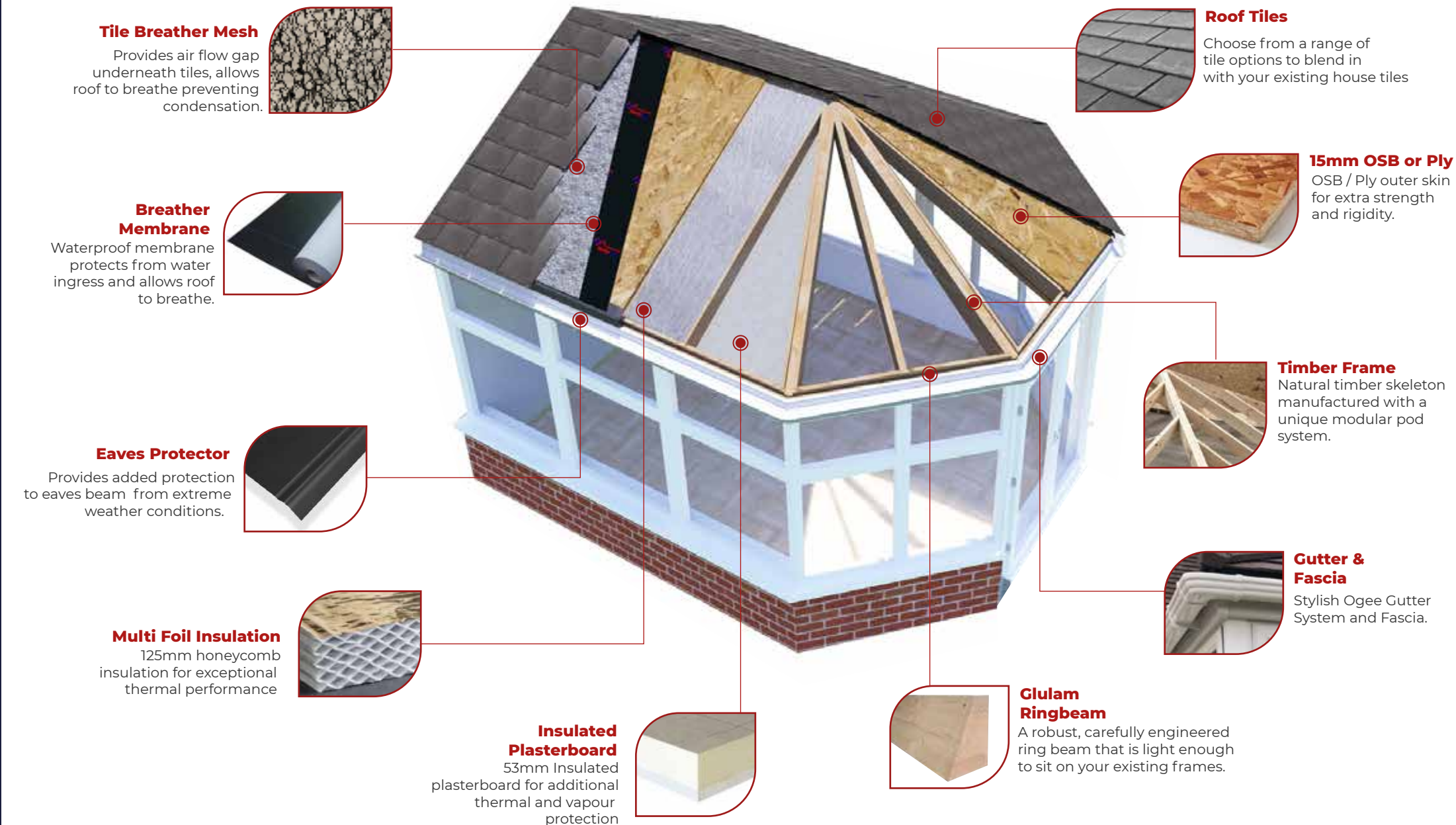





**EXTERNAL SOFFIT**



**ROOF WINDOWS**

**MAKE IT  
YOUR  
OWN**

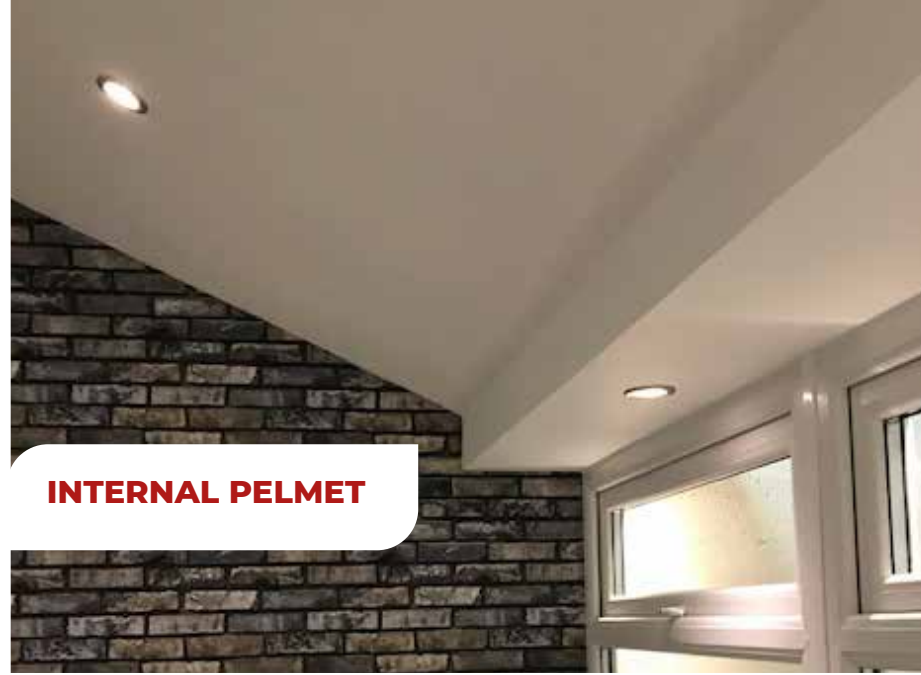

**INTERNAL PELMET**

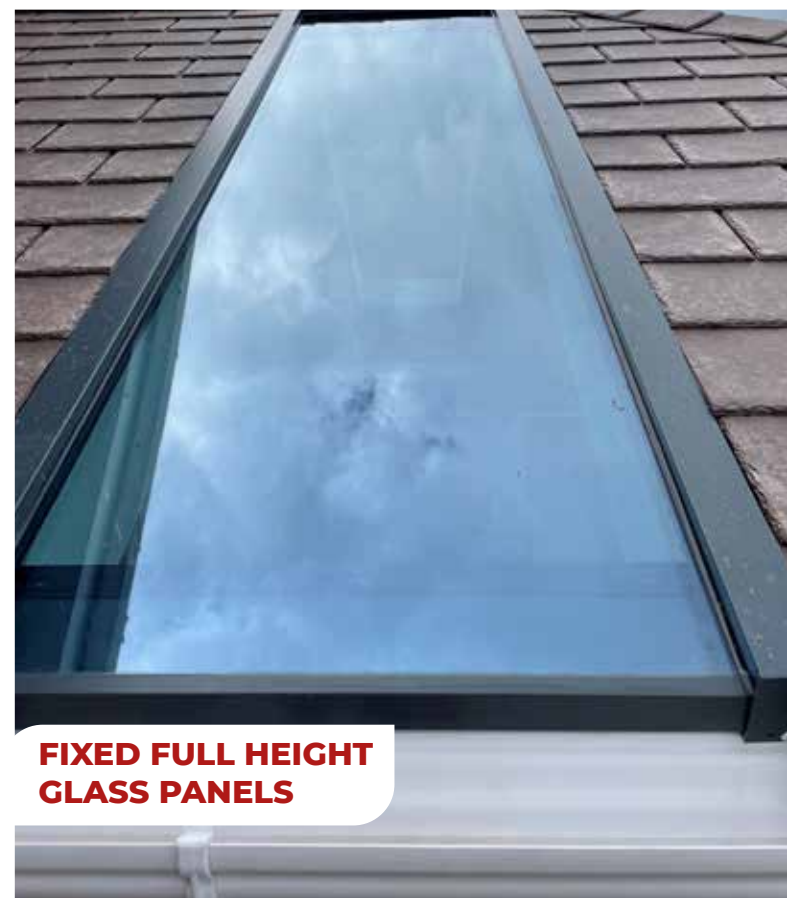

**FIXED FULL HEIGHT  
GLASS PANELS**



**GABLE OVERHANGS**

**CUSTOMISE  
INSIDE AND OUT**



“ OUR CONSERVATORY  
NOW FEELS SO  
**LIGHT AND  
SPACIOUS** ”



**10**  
YEAR  
GUARANTEE

**FASTER** **WARMER**  
**ULTRA-MODERN**

**Patented innovation**

Keylite's unique integrated Expanding Thermal Collar insulates the frame within the roof providing exceptional thermal performance and protects against condensation and mould. Other unique features such as pre-fitted Flick-Fit Brackets simplify the installation, while the Sash Hinge Finger Spring's ensure minimal effort is required to operate and maintain the Roof Window.

**Extra performance**

Keylite provides all of its great features as standard. Other roof windows may require the use of accessories at an additional cost in order to achieve the same performance as Keylite.

**More choice**

Keylite Roof Windows provide you with more choice when selecting the right window for your conservatory. There are innovative upgrades available such as Solar Powered Windows, allowing you to operate day and night without the need for mains electricity.

**Award-winning**

Warmer Roof are proud to supply windows from the award-winning Keylite, giving you peace of mind on receiving a quality Roof Window that will surpass all expectations.



IRISH CONSTRUCTION INDUSTRY AWARDS 2017



HOUSEBUILDER PRODUCT AWARDS 2017



CONSTRUCTION NEWS SPECIALISTS AWARDS 2018



BUILDERS MERCHANTS JOURNAL INDUSTRY AWARDS 2018

**Approved**

Keylite Roof Windows has gained certification from the relevant national bodies giving you confidence that Keylite is the correct window choice for your project.



The mark of responsible forestry

Look for FSC® certified products.

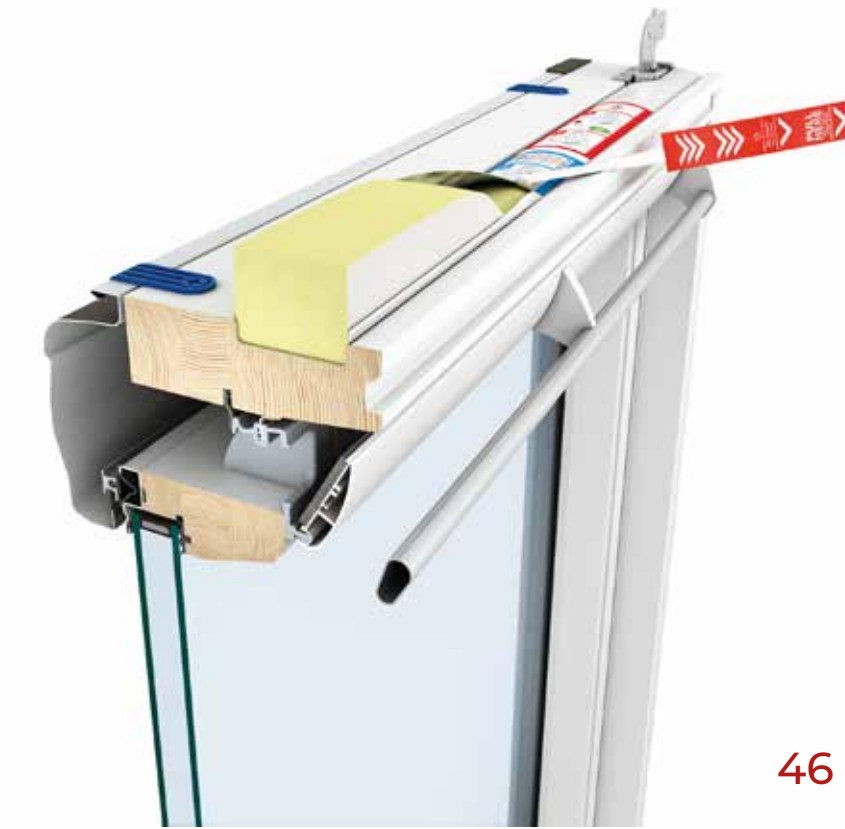



# WINDOW OPTIONS

15° MIN 550 x 780 / 780 x 980 Standard sizes

## Manual Operation

White Painted Pine, Centre Pivot



### Features



#### Attractive Styling

White painted pine internal finish.



#### Window Opening Pole

open your overhead roof window with ease. Pole size: 2m



#### Fresh Air

One click on the top handle provides ventilation, pull further to open for fresh air.



#### Easy Cleaning

Window rotates 180° to clean the glass from inside the room.

## Electric Operation

White Painted Pine, Centre Pivot



### Features



#### Rain Sensor for Auto Closing

Smart rain sensor will automatically close the window in the event of rain, even when you are away from home.



#### Handheld Remote Control

Control your roof windows at the touch of a button. Ideal for hard to reach areas.

## Solar Operation

White Painted Pine, Centre Pivot



### Features



#### Rain Sensor and Auto Closing

Smart rain sensor will automatically close the window in the event of rain, even when you are away from home.



#### Handheld Remote Control

Control your roof windows at the touch of a button. Ideal for hard to reach areas.

Solar Roof Windows harvest solar energy which is retained in the roof window's battery system. With no need for mains electricity, the Solar Powered Roof Window harnesses this energy allowing you to operate your windows day and night.



## INTEGRAL BLINDS







As the blind is sealed within the glazing unit, it requires no cleaning as it is housed in an entirely dust free environment. The blinds can be operated by a handheld remote control.

**Integral blinds are only available with electric operated roof windows**



## BLACKOUT BLINDS

Create atmosphere in your room with our collection of black out blinds. All blinds come with a slim aluminium side rail for smooth operation and a clean classic look. The enclosed cassette protects fabric from discolouration and eliminates glow around the edge. The blinds will reduce heat loss by at least 20% (BBA Tested), giving even more thermal benefits to your room. All blinds are available with manual, electric and solar operation. Electric blinds will require an electric operated roof window.

-  White B51
-  Black B54
-  Beige B52
-  Grey Whisper B09
-  Sandstone B33
-  Fossil Grey B03



# WARMER GLASS PANELS

Give your conservatory roof project the 'wow factor' and allow natural light to flood in by including our very own integrated fixed glass panels, now available in a range of shapes to add a contemporary look and feel to your room.

## Key features

- \* Exceptional thermal performance
- \* Assembled in our UK factory for ultimate quality control
- \* The system has been tested for weathertightness
- \* Bespoke design, tailored to your roof
- \* Unique design that allows for an uncluttered seam to the glass with our eaves beam

15°

Min

600 w / full height

Standard sizes

“ ELEGANCE  
AT ITS FINEST ”

## ADVANCED ENGINEERING TO PROVIDE STUNNING RESULTS

### Glazing

Our standard specification for glass is 28mm clear toughened double glazed units. There is an abundance of different glass specifications to choose from on the market. Glass upgrades such as Activ Self Cleaning and also Activ Blue or Neutral (Grey) Solar controlled options are available just to name a few.

\* Glass unit not supplied with kit. Glass size and spec provided to installer upon order confirmation.

### Unique design

Our innovative design with minimal components offers a stress-free installation to all installers whilst providing truly stunning results. All of our slim aluminium cappings are power coated in anthracite grey for a clean classic look with an internal frameless design offering increased natural light.

### Choice & style

Warmer Roof Glass Panels now provide you with more choice than ever. Our innovative and stylish shaped panels are completely bespoke and are custom made to suit the size and shape of your conservatory roof.

\* Shaped panels only available with Tapco Slate

### Performance

All glazing bars are constructed from aluminium and are fully thermally broken giving superior thermal efficiency coupled with low maintenance and stylish design.

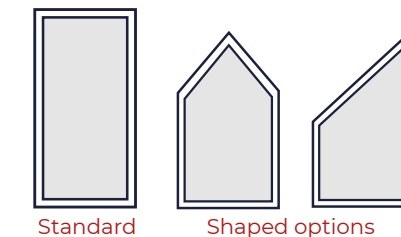



**STUNNING INTERIORS  
THAT TRANSFORM  
YOUR HOME**

**Lighting**



Adding internal spot lights will make your new room feel like part of your home as well as providing extra light.







# FLAT ROOF SYSTEM

With unrivalled looks and thermal performance, the Warmer Flat Roof System combined with a glass lantern will bring stylish ambience to your home whilst maximising natural light, providing you with a bright and airy living space.

Our timber pod system, filled with 125mm of honeycomb insulation offers exceptional thermal performance, covered externally with Firestone EPDM rubber for extreme durability and complemented with a contemporary external soffit detail, perfect for adding spot lights.

All Flat Roofs are Stroma ( Building Regulations ) compliant.



## BRING STYLE TO YOUR HOME

Create the sense of clear free space in your room with our slim and contemporary lantern profile adding style to your home. From the outside Warmer Roofs' discreetly designed external rafter top cappings and slimline ridge are a world apart from the chunky conventional T-bar caps and ridges used by competitors. This unique design creates a feeling of more sky less roof, giving visible elegance to your roof design and appearance.

### Frame Colour options

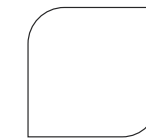

White  
(White interior)



Anthracite  
(Anthracite / white interior)



Black  
(White interior)

### Glass Colour options

#### Sunshield Neutral

EcoClean SUNSHIELD Neutral offers the insulation and self-cleaning properties of EcoClean BLUE, but without the blue tint providing a more natural look.

#### Sunshield Blue

EcoClean SUNSHIELD Blue, as with the whole of the EcoClean range, combines multi coatings to offer self-cleaning technology and optimum solar control properties.

#### Sunshield Aqua

EcoClean SUNSHIELD Aqua with its attractive green tint it deflects 78% of the sun's solar energy, so even on the hottest of summer day's your conservatory can still be enjoyed to its full potential.



## ROOF LANTERNS



# A FEW QUESTIONS WE OFTEN GET ASKED

## **Will a new roof really improve the temperature inside my conservatory?**

Yes certainly! A Warmer Roof will dramatically change the temperature making your room much warmer during the winter and cooler throughout the summer allowing you to enjoy your conservatory all year round.

## **Will my new frames withstand a new roof?**

A Warmer Roof is more or less the same weight as a glass roof. In accordance with Government Guidelines, if the structure shows no signs of distress, the existing foundations are likely to be adequate to carry the small additional loadings. We advise on installers checking the footings and adding reinforcements to frames if necessary.

## **Will my new room feel darker inside?**

A reduction in natural light will occur when replacing your existing roof. Adding opening roof lights with internal lighting will make your room feel bright and airy.

## **Will my new roof be strong enough to stand on to clean house windows?**

Yes, your Warmer Roof is strong enough to stand on but we advise on all health and safety procedures being carried out prior to doing so.

## **Can I make the appearance of my new roof blend in with my house.**

Absolutely, you can customise your Warmer Roof with a range of tile options, gutter and fascia colours to blend in perfectly with your existing home

## **Will a new roof reduce the noise I can hear from outside?**

A Warmer Roof will substantially reduce external noise especially as the roof insulation itself has acoustic performance properties. This considerable noise reduction will allow you to be more relaxed especially during inclement weather.

## **Is condensation really a problem with other roof systems?**

Yes, condensation build up within the roof structure can cause you endless problems down the line such as damp patches, leaks and plasterboard cracking. Our wooden structure combined with our exceptional thermal performance can be sure to put your mind at ease.

## **Do I need Building Control Approval?**

Generally Building Control is required but it is wise to consult with your local council Building Control department as Building Control opinion can vary from council to council. Warmer Roof has full Stroma Building Control accreditation so this makes Building Control applications less complicated as an approved roofing system is being used.



# BEWARE OF CLAD OVER ROOFS

Wrap Over, Wrap under, Wrap Around, also terms used to describe a roof comprising of materials to insulate and cover either internally, externally or both. This procedure will never involve completely taking down your existing conservatory roof which can cause huge structural problems to your property and potentially be extremely dangerous.

Conservatory roofs are only engineered for their original purpose. Whether it is glass or polycarbonate, your existing roof is designed to withstand heavy snowloads and high winds and should not have any additional materials added to change the appearance. Solid roofs need to be much more rigid therefore any original rafters and ridges must be completely removed to avoid leaks, cracked plasterboard or even worse..... from falling down!

Sadly, since the growth of this new lucrative market, numerous companies have started up carrying out non conforming alterations. Generally these types of roofs DO NOT conform to Building Regulations and may have to be removed if you come to sell your property in the future.

### TOP TIP



Ask your installer " will my old roof be COMPLETELY removed?" Watch the initial part of the installation to make sure this happens. There should be no old components left sitting on your frames before a new roof is added.



## THE DANGERS OF CLAD OVER ROOFS



### Structural integrity

Structural integrity is vital for the safety of you and your family. NO structural calculations are carried out for Clad Over roofs.



### Condensation

leaving in original aluminium bars will create condensation issues due to there being NO thermal barrier. this will create leaks, damp patches and plaster cracks.



### Suitable fixings

Your existing conservatory roof has NO fixing solution for a clad over roof. Drilling into existing bars can have extreme effects to the structural integrity of the structure.



### Building Control

Generally Clad Over roofs do NOT comply with building regulations due to their low thermal performance and lack of structural calculations.



### Natural light

Clad Over roofs come without the option of glass panels or opening vents which will remove the option for any additional light.



### Investment payback

Adding a solid roof to your conservatory will add value to your home. A Clad Over WILL NOT. You may need to completely remove your Clad Over roof when you come to sell your home.



SAY **NO** TO CLAD OVERS FOR THE **SAFETY** OF YOU AND YOUR FAMILY!

DO YOUR **RESEARCH** BEFORE YOU **INVEST..**



